

Goedhart FC385



Goedhart FC38D



Goedhart FC38L



Goedhart FC38

Standard air coolers

Cu/Al

R404A - Coolants



Goedhart FC38

The range GEA Goedhart FC38 standard ceiling mounted air coolers are standard air coolers for cooling and freezing applications (FC38S), working/preparation rooms and storage rooms for humidity sensitive products (FC38D) and for cold storage rooms with height limitation (FC38L).

The standard FC38 aircoolers are suitable for all known refrigerants and not corrosive coolants, with the exception of NH3.

Type description

FC38Si(dx) 6.2.40.7-230-E

FC38S = Ceiling mounted air coolers	2	= Number of fans
FC38D = Dual discharge air coolers		
FC38L = Extra low air cooler	40	= Fan diameter in cm
i = internally enhanced tubes	7	= Fin spacing
p = plain tubes		
(dx) = R404A	230	= 1x230V Fan tension
(G) = coolant	400	= 3x400V Fan tension
6 = number of tubes deep	E	= Electrical defrost
	H	= Hot gas defrost

General features

Coil block

- Tube distance : 38x33 mm versprongen
- Tubes : 12mm o.d copper tube
- : I= internally enhanced tubes for refrigerants (dx)
P= internally plain tubes for coolants(G) and refrigerants (dx)
- Fins : aluminium HT-fins
- Fin spacing : 4 mm : Suitable for applications with air temperatures above 0°C and with expected limited frost
: 7 mm : Suitable for applications with air temperatures below 0°C and expected frost
- A good thermal with the fins contact because the copper tubes are mechanically expanded into fully collared aluminium fins.
- The suction header is executed with a Schröder valve for testing applications
- All coil blocks for refrigerants are pressure tested to 40 bars. All coil blocks for coolants are pressure tested to 15 bars.
- FC38 aircoolers are supplied with a light overpressure charge.

General features

Casing

- Standard refrigerant connections are fixed on the left hand side of the unit when looking with the direction of the air flow.
- Construction suitable for mounting to the ceiling.
- The FC38 casing is made from galvanized sheet steel, with exception of:
 - FC38S drip tray is hinged and made from light aluminum.
 - FC38D has a fixed galvanized drip tray.
 - FC38L drip tray is hinged and made from light aluminum.
- The fans of the FC38D are mounted to the outside of the drip tray of the air cooler and are wired.
- Goedhart FC38SB and FC38L air cooler is executed with a short air conduction plate as standard.
- The casing has a corrosion resistant white epoxy spray finish (RAL 9003).
- Almost all fixing materials are made of stainless steel to prevent corrosion.
- A possible hot gas spiral or electric defrost elements will be fixed to the bottom side of the coil

Standard options

Optional extra's	FC38S	FC38D	FC38L
Draw through execution	•		
Insulated drip tray	•		
StSt casing	•	•	•
Goldlack fins (4 / 7 mm)	•	•	•
Almg fins (4 mm)	•	•	•

Options on request

Optional extra's	FC38S	FC38D	FC38L
Hot gas defrost	•		
Warm glycol defrost	•		
Fan heating	•		•
Splash plate	•		
StSt tubes	•	•	•

P.E.D.

All air coolers produced by Goedhart comply with the Pressure Equipment Directive 97/23/EC. PED certificates can be downloaded from www.goedhart.nl.

Guarantee

Goedhart gives in conformity with her general conditions of delivery the following guarantee period on the Goedhart FC38 air coolers:

- within a 12 month period of product use
- at the latest within 18 months after the time of delivery.

Sound data

The mean sound pressure (LpA @ 3m ± 2 dB (A)) each air cooler is a calculated indication value according to the EN13487 standard parallel pipe. Goedhart uses the fan manufacturer's sound power level (LwA) at the inlet side of the fan. Changes to or by the fan or the product, affect the sound, in these cases, consult the manufacturer for the new indication value. In critical sound requirements, we advise you to consult an expert.

Defrost systems

For room temperatures where ripe formation can be expected and where the coil can not be defrosted by the room air, electrical or hot gas defrost is necessary

Electrical defrost

On request FC38 can be provided with electrical defrost. FC38 is always delivered with heavy defrost. The heater elements are rated for 220/240 V and are 400/420 V with zero wire supply. The stainless steel heater elements are fitted in the coil block in inner tubes which form a highly conductive medium between the heaters and the fins. In the drip-tray, the heater elements are fitted to the bottom side of the underside of the aluminum inner tray. The heater elements in the coil block are removable from the header side of the unit, whilst the tray heater elements can be removed once the outer tray has been taken off.

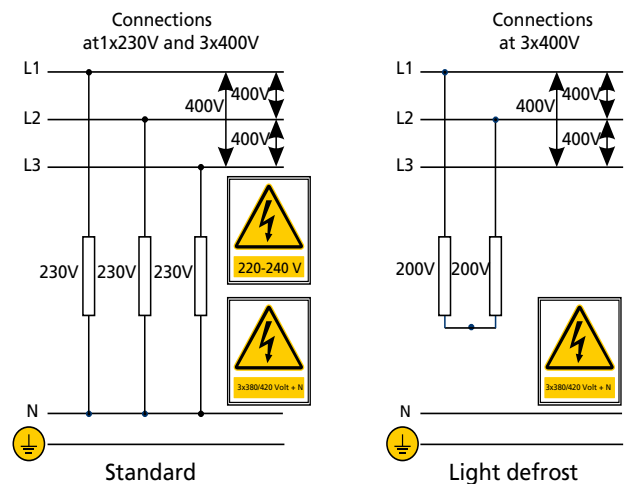

Hot gas defrost

The coil block is suited for hot gas defrost (hot gas supply through the suction header). The drip tray can be provided with a copper hot gas spiral, which is enclosed in special aluminum profiles, which are rigidly secured to underside of the aluminum inner tray.

Mounting & Maintenance

FC38 is delivered in a wooden crate. FC38S will be delivered with the separate drip-tray. When crated, FC38 can be handled by crane or fork-lift truck, which makes it very easy to mount. The drip-tray of the FC38S is delivered separately. For maintenance and instructions see our manual delivered on order or can be downloaded from our web site www.goedhart.nl.



Fans

GEA Goedhart FC38 aircoolers are executed with Ziehl Abegg: (We reserve the right to alter the manufacturer).

The fans are suitable for operation in air temperatures between -25°C to +40°C. When the air temperature is lower than -25°C, special fans are needed. These special fans have a longer delivery time. The protection class is IP54. The fans are not available with stainless steel protection guards

At all GEA Goedhart FC38 air cooler types (FC38S, FC38D and FC38L) the fans are mounted to the outside of aircooler!

The technical data in the table are the same as on the motor name plates and is valid for an air temperature of +20 °C. Also the data are given for working in an air temperature of 0 °C and -20 °C.

1x230V-50Hz

The standard connection tension for the Ziehl Abegg fans is 230V-50Hz-1 phase for the fan diameters Ø250, Ø300, Ø350, Ø400, Ø450 and Ø500. The fan motors of the Ø250, Ø300 and Ø350 mm fans are standard equipped with internally connected thermo contacts. Ø400, Ø450 and Ø500 mm fans are equipped with thermal contacts lead outside.

3x400V-50Hz

The EBMpapst Ø400, Ø450 and Ø500 fan is on request available in 230/400V-50Hz-3 phase. The fan is executed with a thermal contact lead to the outside.

Connecting thermal contacts

If the thermal contacts are not connected the warranty on the fans expires.

Frequency controlling

When a frequency converter is applied, always an All pole sinus filter should be used!

Fan type	Values at 1x230V-50Hz					Sound power indication ach fan LwA (+/-2dB(A))	Wiring diagram
	Speed	Input	+20°C	0°C	-20°C		
			FLC	FLC	FLC		
rpm	[W]	[A]	[A]	[A]	[dBA]		
4 pole fans (1500 rpm nominal)							
FN025	1370	50	0,24	0,26	0,28	62	177X
FN030	1290	90	0,39	0,43	0,45	65	177X
FN035	1260	170	0,75	0,82	0,87	75	177X
FN040	1370	240	1,10	1,20	1,28	76	104XB
FN045	1320	550	2,50	2,73	2,90	80	104XB
FN050	1230	750	3,30	3,60	3,83	81,5	104XB
6 pole fans (1000 tpm nominal)							
FN040	950	130	0,58	0,63	0,67	68	104XB
FN045	910	190	0,90	0,98	1,04	68,5	104XB
FN050	910	300	1,30	1,42	1,51	71,5	104XB

Fan type	Values at 3x400V(Δ)-50Hz					Sound power indication ach fan LwA (+/-2dB(A))	Wiring diagram
	Speed	Input	+20°C	0°C	-20°C		
			FLC	FLC	FLC		
rpm	[W]	[A]	[A]	[A]	[dBA]		
4 pole fans (1500 rpm nominal)							
FN040	1370	230	0,40	0,44	0,46	76	108XB
FN045	1250	350	0,64	0,69	0,74	78	108XB
FN050	1300	770	1,70	1,85	1,97	81	108XB

Wiring diagram

Ziehl Abegg 1x230V-50Hz (177X)

U2= blue or grey
Z2= black
TB=braun

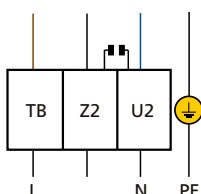

Ziehl Abegg 3x400V (Δ)-50Hz (108XB)

U1 =braun
V1 =blue
W1=black
U2 =red
V2 =grey
W2=orange
TB =white

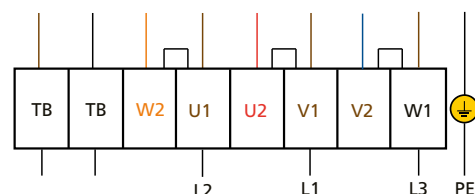

Ziehl Abegg 1x230V-50Hz (104XB)

U1 =braun
U2 =blue
Z1 =black
Z2 =orange
TB =white

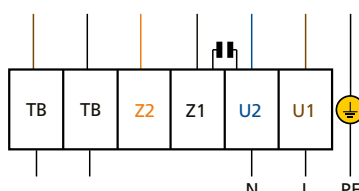

Ziehl Abegg 3x400V (Y)-50Hz (108XB)

U1 =braun
V1 =blue
W1=black
U2 =red
V2 =grey
W2=orange
TB =white

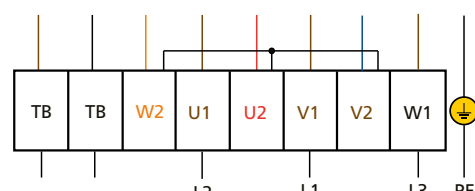

Goedhart FC38Li(dx) - R404A

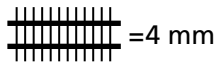

Type	Fan diameter	1x230V-50Hz-4 pole (1500 min ⁻¹ nom.)					Surface	Connections		Weight	Internal volume	Air cooler details
		SC1	SC2	SC3				I	K			
FC38L	mm	DT1 = 10K Air on =10°C 0 / +10	DT1 = 8K Air on =0°C -8 / 0	DT1 = 7K Air on =-18°C -25 / -18	Air volume	LpA @ 3 m (+/- 2 dB(A))*	m ²	mm	mm	kg	dm ³	
6.1.25.4	1x250	2,3	1,6		510	40,8	9	12	12	15	2	
6.1.30.4	1x300	3,7	2,6		841	43,7	13	12	28	20	3	
6.1.40.4	1x400	9,6	6,6		2287	54,4	29	16	28	40	7	
6.2.25.4	2x250	4,6	3,2		1020	43,7	18	12	28	25	4	
6.2.30.4	2x300	7,4	5,1		1681	46,5	26	12	28	35	6	
6.2.40.4	2x400	19,1	13,0		4573	57,1	58	16	35	60	13	
6.3.30.4	3x300	11,2	7,7		2522	48,1	39	16	28	45	9	
6.3.40.4	3x400	28,8	19,7		6860	58,6	87	16	35	90	19	
6.4.30.4	4x300	14,8	10,2		3363	49,2	52	16	28	60	11	

* = Sound pressure indication (LpA) at 3 m distance each air cooler (+/- 2 dB(A)) , free field conditions, according EN13487

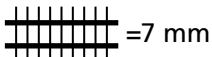

Type	Fan diameter	1x230V-50Hz-4 pole (1500 min ⁻¹ nom.)					Surface	Connections		Weight	Internal volume	Air cooler details
		SC1	SC2	SC3				I	K			
FC38L	mm	DT1 = 10K Air on =10°C 0 / +10	DT1 = 8K Air on =0°C -8 / 0	DT1 = 7K Air on =-18°C -25 / -18	Air volume	LpA @ 3 m (+/- 2 dB(A))*	m ²	mm	mm	kg	dm ³	
6.1.25.7	1x250	2,0	1,4	1,0	612	40,8	5	12	12	15	2	
6.1.30.7	1x300	3,2	2,2	1,6	1061	43,7	8	12	28	20	3	
6.1.40.7	1x400	8,0	5,4	4,0	2764	54,4	17	16	28	30	7	
6.2.25.7	2x250	4,1	2,8	2,0	1225	43,7	11	12	28	20	4	
6.2.30.7	2x300	6,6	4,5	3,3	2122	46,5	16	12	28	30	6	
6.2.40.7	2x400	15,8	10,8	7,8	5527	57,1	35	12	35	55	13	
6.3.30.7	3x300	9,8	6,7	4,9	3184	48,1	23	16	28	40	9	
6.3.40.7	3x400	24,1	16,4	12,0	8291	58,6	52	16	35	80	19	
6.4.30.7	4x300	13,2	9,0	6,5	4245	49,2	31	16	28	55	11	

* = Sound pressure indication (LpA) at 3 m distance each air cooler (+/- 2 dB(A)) , free field conditions, according EN13487

Goedhart FC38Li(dx) - R404A

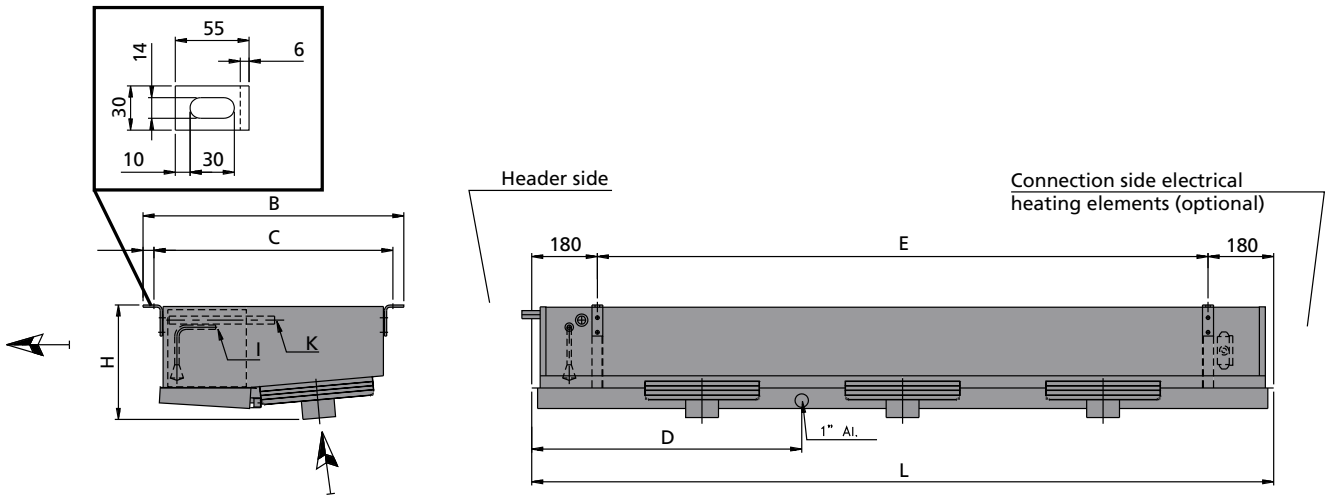

Declarations

Connection ≤ 35 mm	: Declaration of incorporation (SEP)
Connection 42mm and 54 mm	: module A
Group of fluid	: 2
PS	: 28 bar
TS	: +55 / -40 °C

Type	Dimensions					Electrical defrost at 3x400V-50Hz				Standard kW	Dimensions & Electrical defrost
	L	B	H	E	D1	Coil block		Drip tray			
	mm	mm	mm	mm	mm	number	O [mm]	number	O [mm]		
FC38L	mm	mm	mm	mm	mm	number	O [mm]	number	O [mm]	kW	
6.1.25.*	890	705	280	530	245	2x L=1300	132	1x L=1300	175	1,5	
6.1.30.*	990	705	315	630	295	2x L=1600	132	1x L=1600	175	1,9	
6.1.40.*	1190	865	465	830	295	3x L=1900	132	1x L=2200	175	3,2	
6.2.25.*	1390	705	280	1030	695	2x L=2500	132	1x L=2500	175	3,1	
6.2.30.*	1590	705	315	1230	795	2x L=2800	132	1x L=2800	175	3,5	
6.2.40.*	1990	865	465	1630	995	3x L=3700	132	1x L=3700	175	6,2	
6.3.30.*	2190	705	315	1830	795	2x L=4000	132	1x L=4000	175	5,0	
6.3.40.*	2790	865	465	2430	995	3x L=5200	132	1x L=5200	175	8,8	
6.4.30.*	2790	705	315	2430	1395	2x L=5200	132	1x L=5200	175	6,6	



Best of both worlds

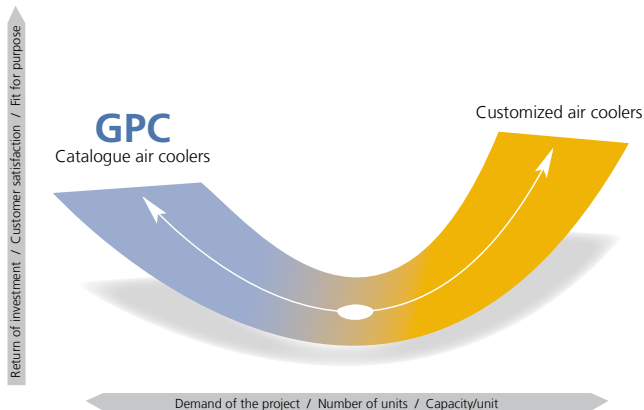

Goedhart GPC Program,
your selection software
 for air coolers and air
 cooled condensers!

One question which always is in the mind of an industrial refrigeration engineer is the following:
 Do I ask for standard or shall I go for tailor made?

There are good reasons for both choices. In some cases, the solution needed is beyond the boundaries of the standard program. In other occasions, tailor made can even offer a more economical solution. In again other situations standard would be the logical choice to go for.

In any of the cases GEA Goedhart can offer you the right solution. With the standard selection software GPC finding the right heat exchanger is just a few mouse clicks away. On other cases the GEA Goedhart engineers are happy to help you out!

Goedhart FC38 air cooler selections are available in the Goedhart Product Catalogue or GPC.

On the tool section of www.goedhart.nl you will find the download button for the latest version of the GPC.

The GPC program is an easy to use tool for contractors, consultants and every other thinkable user and gives you access to many advantages such as:

- Multilingual
- The whole range of GEA Goedhart standard air coolers and air cooled condensers
- Pre-select buttons to application
- Selections including drawings and an extensive list of accessories
- Spare parts
- Accurate capacities: Under the GPC shell hides a sophisticated capacity calculation program which optimizes circuits to the design conditions as you work!

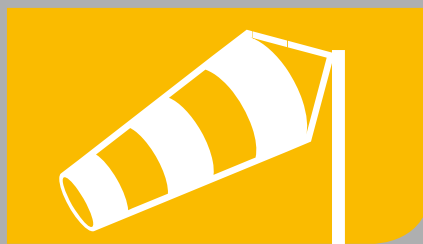
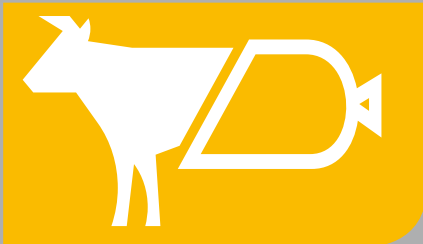
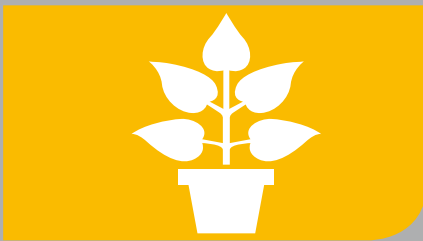

For Contractors and Original Equipment Manufacturers (OEM) related to the industrial refrigeration industry, GEA Goedhart B.V. offers an unlimited range of air coolers and air cooled condensers in several configurations.

Depending on the application, the optimum configuration will be selected in close cooperation with our customers.

Configurations

The following material combinations are available in various tube pitches and various fin spacing:

Tube material	Fin material
Copper (Cu)	Aluminium (Al)
Stainless steel (Stst)	Aluminium (Al)
Stainless steel (Stst)	Stainless steel (Stst)
Aluminium (Al)	Aluminium (Al)
Hot dipped galvanized steel (FeZn)	Hot dipped galvanized steel (FeZn)

Options on aluminium fins

- Goldlack coated fins
- Seawater resistant aluminium fins (AlMg)

Applications

Cooling	Freezing
Cold stores / Distribution centres	Cold stores / Distribution centres
Food processing rooms	Tunnel / spiral freezers
Fruit storage	Slaughter houses
Banana ripening storage	Automotive testing rooms
Greenhouse conditioning	Ski domes

Pressure Equipment Directive (P.E.D.)

All aircoolers produced by Goedhart comply with the Pressure Equipment Directive 97/23/EC. PED certificates can be downloaded from www.goedhart.nl.

GEA Goedhart
air coolers
for every application

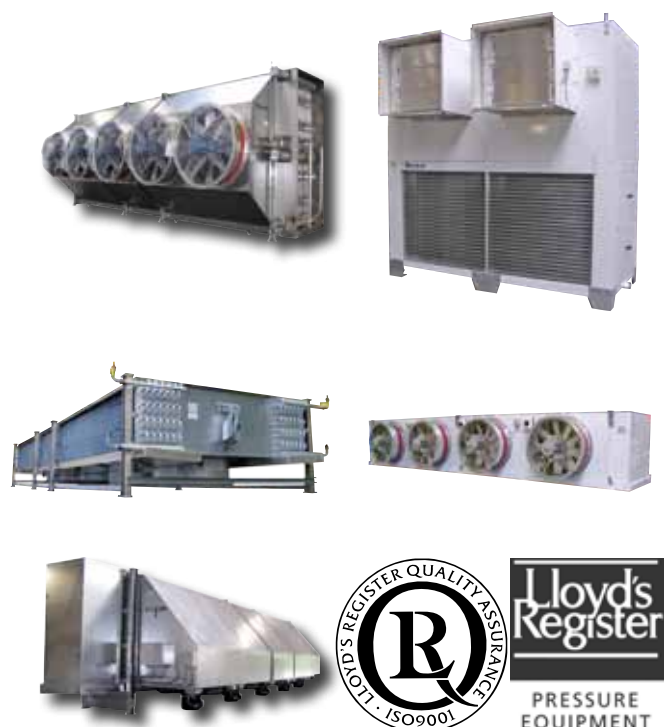



Excellence

Passion

Integrity

Responsibility

GEA-versity

GEA Group is a global mechanical engineering company with multi-billion euro sales and operations in more than 50 countries. Founded in 1881 the company is one of the largest providers of innovative equipment and process technology. GEA Group is listed in the STOXX Europe 600 Index.



GEA Heat Exchangers

GEA Goedhart B.V.

Nijverheidsweg 6, 4695 RC Sint Maartensdijk
The Netherlands
Phone +31 (0)166 665 665, Fax+31 (0)166 663 698
www.goedhart.nl,
info.goedhart.nl@geagroup.com

GEA Heat Exchangers

GEA Goedhart s.r.o.

Kostomlátecká 180, 288 26 Nymburk
Czech Republic
Phone +420 325 519 951, Fax+420 325 519 952
www.goedhart.cz,
goedhart.cz@geagroup.com